

A

B

C

D

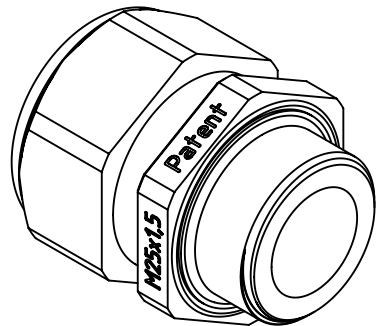
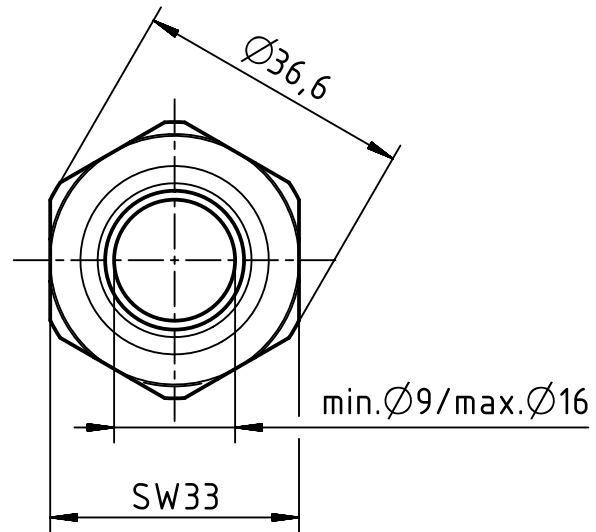
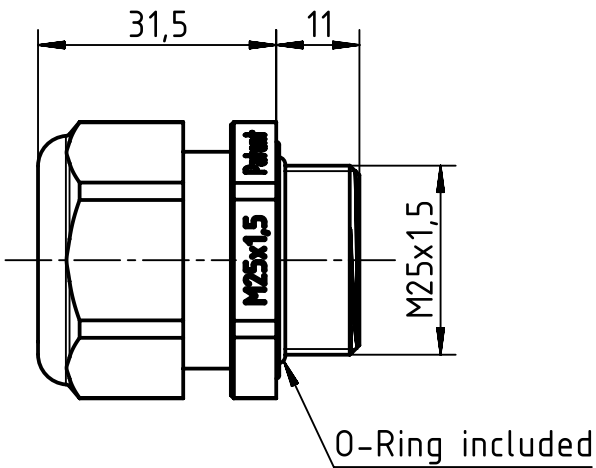

	All Dimensions in mm Original Size DIN A4		Scale 1:1	Free size tol.		Ref.
						Sub.
	All rights reserved		Created by LONGL	Inspected by DINGB	Standardisation TIEMANNA	Date 2016-03-04
	Department EL PD - DE		Title Han CGM-P M25x1,5 D.9-16mmblack			State Final Release
HARTING Electric GmbH & Co. KG D-32339 Espelkamp			Type TB	Number 19 00 000 5191		Doc-Key / ECM-Nr. 100625056/UGD/002/B 500000100783
					Rev. B	Page 1/1